

Industrial Duty Three-Phase Motors

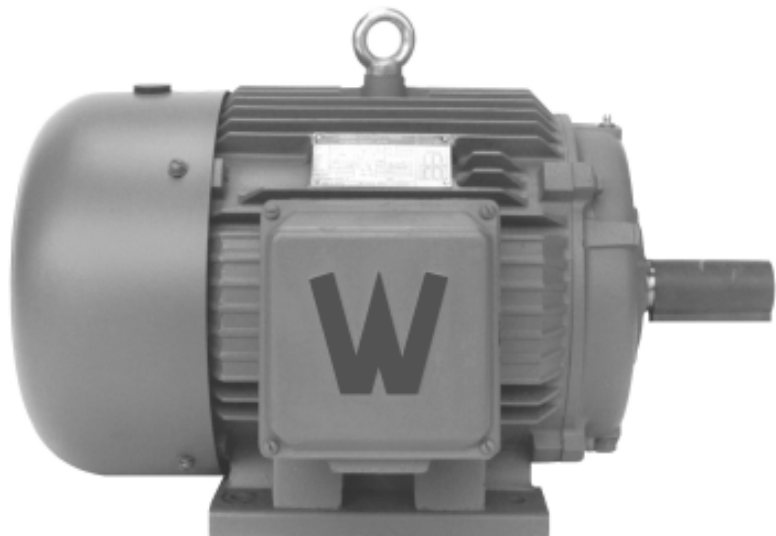

Motors Included In This Brochure

- ▶ 1 HP - 500 HP
- ▶ 3600, 1800, 1200 & 900 RPM
- ▶ EPACT Rated
- ▶ Premium Grade Quality
- ▶ All Cast Iron Frames
- ▶ T-Frame Motors
- ▶ Large HP TS-Frame Short Shaft Motors
- ▶ 575 Volt Motors
- ▶ Drive-End Ball Bearings Or Roller Bearings Available On All Large HP Motors

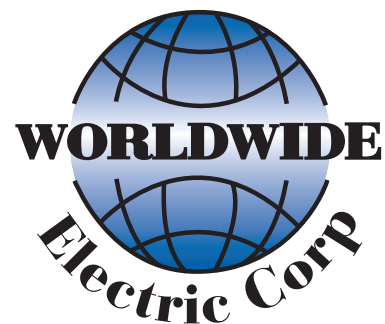

**High Quality Industrial Duty
Three-Phase Motors Available
To You At Factory-Direct Prices!**

WorldWide Electric Corporation



WorldWide Electric Motors

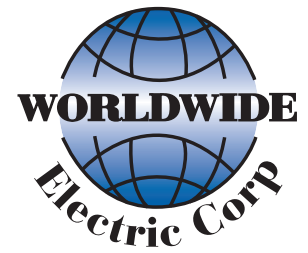

**Made With Only The Very Finest Equipment
In The Very Finest Manufacturing Centers**



Motors Made By One Of The Leading Motor Manufacturers In All Of Asia For Over 45 Years.



Worldclass Accreditations With A Long History Of Quality Testing Procedures And Standards Performed By The Finest Independent Testing Laboratories In The World.



WorldWide Motors Are Made In High Quality ISO9001 Certified Facilities. WorldWide Factories Are Vertically Integrated To Ensure A High Quality, Consistent And Steady Flow Of Product From The Factory To The United States Marketplace.



On-Site ISO9001 Foundries (2) Complete The Vertical Integration Process Providing Some Of The Highest Quality All-Cast-Iron Frames The NEMA Market Has To Offer.



Only The Highest Quality Material (And Manufacturing Process) Is Used In The Making Of The WorldWide Electric T-Frame Motor Line.

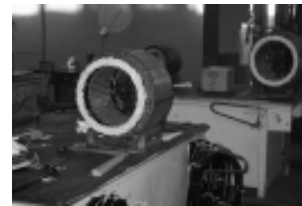

All Motors Are Electrically Tested In Sub-Assembly And Again After Being Fully Assembled.



Almost Three Decades Of Experience Exporting / Importing NEMA Motors Into The United States Market, Using Only Internationally Known Shipping Companies, Guaranteeing A Steady Stream Of Incoming (And On-Time) Stock.



Individually Wrapped And Packaged In The Sturdiest Crates, Using Only First-Cut, Best Quality Lumber. Your Motors Will Look Factory Fresh When Opened.



**Quality Made Motors
With A Long History In
The United States Market**



Industrial Duty Three-Phase Motors

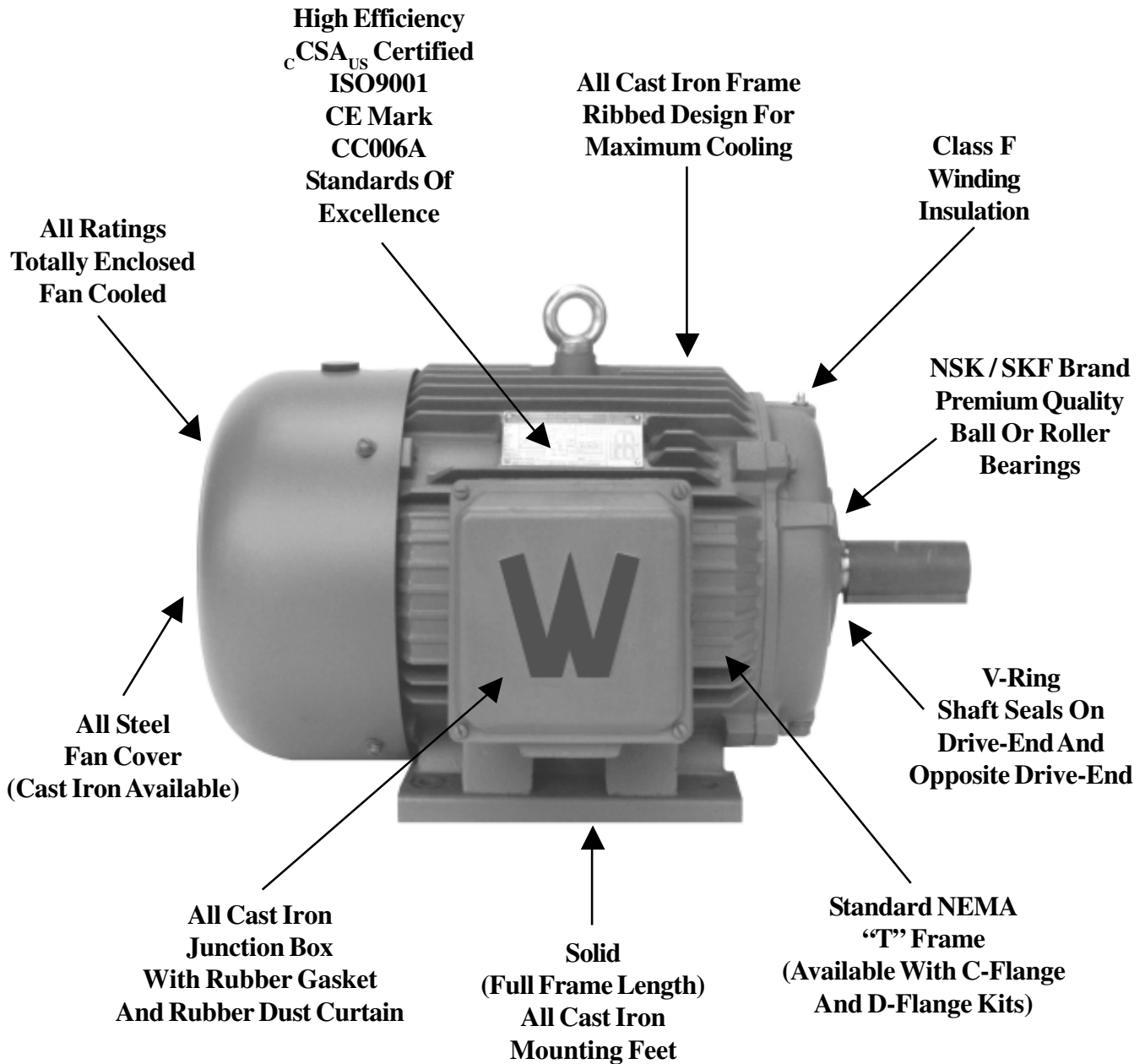

ISO9001



CC006A

Industrial Duty Three-Phase Motors



- ▶ 1 HP - 500 HP
- ▶ 3600, 1800, 1200 & 900 RPM
- ▶ 208-230/460 Volt
- ▶ TEFC Enclosure

HP	RPM	Voltage	Frame Size	Model Number	List * Price
1	1800	208-230/460	143T	WWE1-18-143T	\$277.90
1	1200	208-230/460	145T	WWE1-12-145T	\$375.23
1.5	3600	208-230/460	143T	WWE1.5-36-143T	\$339.67
1.5	1800	208-230/460	145T	WWE1.5-18-145T	\$347.42
1.5	1200	208-230/460	182T	WWE1.5-12-182T	\$403.03
2	3600	208-230/460	145T	WWE2-36-145T	\$384.01
2	1800	208-230/460	145T	WWE2-18-145T	\$361.33
2	1200	208-230/460	182T	WWE2-12-182T	\$521.20
3	3600	208-230/460	145T	WWE3-36-145T	\$541.52
3	3600	208-230/460	182T	WWE3-36-182T	\$487.37
3	1800	208-230/460	182T	WWE3-18-182T	\$471.07
3	1200	208-230/460	213T	WWE3-12-213T	\$738.10
5	3600	208-230/460	184T	WWE5-36-184T	\$607.89
5	1800	208-230/460	184T	WWE5-18-184T	\$508.88
5	1200	208-230/460	215T	WWE5-12-215T	\$931.07
5	900	208-230/460	254T	WWE5-9-254T	\$1,508.96
7.5	3600	208-230/460	184T	WWE7.5-36-184T	\$904.71
7.5	3600	208-230/460	213T	WWE7.5-36-213T	\$814.24
7.5	1800	208-230/460	213T	WWE7.5-18-213T	\$700.57
7.5	1200	208-230/460	254T	WWE7.5-12-254T	\$1,146.51
7.5	900	208-230/460	256T	WWE7.5-9-256T	\$1,660.72
10	3600	208-230/460	215T	WWE10-36-215T	\$934.51
10	1800	208-230/460	215T	WWE10-18-215T	\$808.82
10	1200	208-230/460	256T	WWE10-12-256T	\$1,563.40
10	900	208-230/460	284T	WWE10-9-284T	\$2,401.78
15	3600	208-230/460	215T	WWE15-36-215T	\$1,564.24
15	3600	208-230/460	254T	WWE15-36-254T	\$1,407.81
15	1800	208-230/460	254T	WWE15-18-254T	\$1,199.85
15	1200	208-230/460	284T	WWE15-12-284T	\$1,959.38
15	900	208-230/460	286T	WWE15-9-286T	\$3,107.18
20	3600	208-230/460	256T	WWE20-36-256T	\$1,602.26
20	1800	208-230/460	256T	WWE20-18-256T	\$1,362.88
20	1200	208-230/460	286T	WWE20-12-286T	\$2,358.47
20	900	208-230/460	324T	WWE20-9-324T	\$3,642.89
25	3600	208-230/460	256T	WWE25-36-256T	\$2,198.98
25	3600	208-230/460	284T	WWE25-36-284T	\$2,198.98
25	3600	208-230/460	284TS	WWE25-36-284TS	\$1,979.08
25	1800	208-230/460	284T	WWE25-18-284T	\$1,893.18
25	1200	208-230/460	324T	WWE25-12-324T	\$2,845.74
25	900	208-230/460	326T	WWE25-9-326T	\$4,091.93
30	3600	208-230/460	286T	WWE30-36-286T	\$2,405.35
30	3600	208-230/460	286TS	WWE30-36-286TS	\$2,164.82
30	1800	208-230/460	286T	WWE30-18-286T	\$2,061.39
30	1200	208-230/460	326T	WWE30-12-326T	\$3,345.02
30	900	208-230/460	364T	WWE30-9-364T	\$4,913.65
40	3600	208-230/460	286T	WWE40-36-286T	\$3,196.61
40	3600	208-230/460	286TS	WWE40-36-286TS	\$3,196.61
40	3600	208-230/460	324T	WWE40-36-324T	\$3,196.61
40	3600	208-230/460	324TS	WWE40-36-324TS	\$2,876.95
40	1800	208-230/460	324T	WWE40-18-324T	\$2,688.65
40	1200	208-230/460	364T	WWE40-12-364T	\$4,157.21
40	900	208-230/460	365T	WWE40-9-365T	\$6,099.72

HP	RPM	Voltage	Frame Size	Model Number	List * Price
50	3600	208-230/460	326T	WWE50-36-326T	\$3,995.77
50	3600	208-230/460	326TS	WWE50-36-326TS	\$3,596.20
50	1800	208-230/460	326T	WWE50-18-326T	\$3,437.67
50	1200	208-230/460	365T	WWE50-12-365T	\$5,449.18
50	900	208-230/460	404T	WWE50-9-404T	\$7,201.09
60	3600	208-230/460	364T	WWE60-36-364T	\$5,377.57
60	3600	208-230/460	364TS	WWE60-36-364TS	\$4,839.82
60	1800	208-230/460	364T	WWE60-18-364T	\$4,540.99
60	1200	208-230/460	404T	WWE60-12-404T	\$6,114.32
60	900	208-230/460	405T	WWE60-9-405T	\$8,183.80
75	3600	208-230/460	365T	WWE75-36-365T	\$6,704.54
75	3600	208-230/460	365TS	WWE75-36-365TS	\$6,034.09
75	1800	208-230/460	365T	WWE75-18-365T	\$5,250.86
75	1200	208-230/460	405T	WWE75-12-405T	\$6,299.73
75	900	208-230/460	444T	WWE75-9-444T	\$11,953.80
100	3600	208-230/460	405TS	WWE100-36-405TS	\$7,143.82
100	1800	208-230/460	405T	WWE100-18-405T	\$5,991.30
100	1200	208-230/460	444T	WWE100-12-444T	\$9,258.03
100	900	208-230/460	445T	WWE100-9-445T	\$12,877.26
125	3600	208-230/460	444TS	WWE125-36-444TS	\$8,963.26
125	1800	208-230/460	444T	WWE125-18-444T	\$8,704.28
125	1200	208-230/460	445T	WWE125-12-445T	\$10,463.28
125	900	208-230/460	445/7T	WWE125-9-445/7T	\$16,545.52
150	3600	208-230/460	445TS	WWE150-36-445TS	\$10,884.01
150	1800	208-230/460	445T	WWE150-18-445T	\$9,441.07
150	1200	208-230/460	445/7T	WWE150-12-445/7T	\$13,365.22
150	900	208-230/460	449T	WWE150-9-449T	\$18,835.80
200	3600	208-230/460	447TS	WWE200-36-447TS	\$14,234.74
200	1800	208-230/460	445/7T	WWE200-18-445/7T	\$12,703.45
200	1200	460	449T	WWE200-12-449T	\$15,710.23
200	1200	208-230/460	505Z(UZ)	WWE200-12-505Z(UZ)	\$17,532.51
200	900	460	449T	WWE200-9-449T	\$21,174.00
250	3600	460	449TS	WWE250-36-449TS	\$19,435.49
250	1800	460	449T	WWE250-18-449T	\$16,074.08
250	1800	460	505Z(UZ)	WWE250-18-505Z(UZ)	\$18,321.44
250	1200	460	449T	WWE250-12-449T	\$21,168.48
250	1200	460	586/7(UZ)	WWE250-12-586/7(UZ)	\$28,293.22
250	900	460	586/7(UZ)	WWE250-9-586/7(UZ)	\$35,454.71
300	1800	460	449T	WWE300-18-449T	\$21,808.72
300	1800	460	586/7(UZ)	WWE300-18-586/7(UZ)	\$26,198.25
300	1200	460	449T	WWE300-12-449T	\$25,161.73
300	1200	460	586/7(UZ)	WWE300-12-586/7(UZ)	\$30,572.28
300	900	460	586/7	WWE300-9-586/7	\$36,805.56
350	1800	460	586/7(UZ)	WWE350-18-586/7(UZ)	\$27,342.46
350	1200	460	586/7(UZ)	WWE350-12-586/7(UZ)	\$31,529.30
400	1800	460	586/7(UZ)	WWE400-18-586/7(UZ)	\$29,389.79
400	1200	460	586/7(UZ)	WWE400-12-586/7(UZ)	\$34,071.48
450	1800	460	586/7(UZ)	WWE450-18-586/7(UZ)	\$36,359.78
450	1200	460	586/7(UZ)	WWE450-12-586/7(UZ)	\$37,413.08
500	1800	460	586/7(UZ)	WWE500-18-586/7(UZ)	\$37,722.53
500	1200	460	586/7(UZ)	WWE500-12-586/7(UZ)	\$40,184.66

* Prices In This Brochure Are List - Please Call For Your Multiplier

Industrial Duty Three-Phase Motors



Short Shaft Motors (TS-Frame)

- ▶ 25 HP - 300 HP
- ▶ 1800 RPM
- ▶ TEFC Enclosure

HP	RPM	Voltage	Frame Size	Model Number	List * Price
25	1800	208-230/460	284TS	WWE25-18-284TS	\$2,103.53
30	1800	208-230/460	286TS	WWE30-18-286TS	\$2,290.43
40	1800	208-230/460	324TS	WWE40-18-324TS	\$2,987.39
50	1800	208-230/460	326TS	WWE50-18-326TS	\$3,819.63
60	1800	208-230/460	364TS	WWE60-18-364TS	\$5,045.54
75	1800	208-230/460	365TS	WWE75-18-365TS	\$5,834.29
100	1800	208-230/460	405TS	WWE100-18-405TSBB	\$6,657.00
125	1800	208-230/460	444TS	WWE125-18-444TSBB	\$9,671.42
150	1800	208-230/460	445TS	WWE150-18-445TSBB	\$10,490.08
200	1800	208-230/460	445/7TS	WWE200-18-445/7TSBB	\$14,114.94
250	1800	460	449TS	WWE250-18-449TSBB	\$17,860.09
300	1800	460	449TS	WWE300-18-449TSBB	\$24,231.91

Ball Bearing Motors

- ▶ 100 HP - 350 HP
- ▶ 1800 RPM
- ▶ TEFC Enclosure

HP	RPM	Voltage	Frame Size	Model Number	List * Price
100	1800	208-230/460	405T	WWE100-18-405TBB	\$5,991.30
125	1800	208-230/460	444T	WWE125-18-444TBB	\$8,704.28
150	1800	208-230/460	445T	WWE150-18-445TBB	\$9,441.07
200	1800	208-230/460	445/7T	WWE200-18-445/7TBB	\$12,703.45
250	1800	460	449T	WWE250-18-449TBB	\$16,074.08
300	1800	460	449T	WWE300-18-449TBB	\$21,808.72
300	1800	460	586/7	WWE300-18-586/7BB	\$26,198.25
350	1800	460	586/7UZ	WWE350-18-586/7UZBB	\$27,342.46
400	1800	460	586/7	WWE400-18-586/7BB	\$29,389.79
500	1800	460	586/7	WWE500-18-586/7BB	\$37,722.53

575 Volt Motors

- ▶ 1 HP - 500 HP
- ▶ 1800 RPM
- ▶ TEFC Enclosure

HP	RPM	Voltage	Frame Size	Model Number	List * Price
1	1800	575	143T	WWE1-18-575-143T	\$308.78
1.5	1800	575	145T	WWE1.5-18-575-145T	\$386.03
2	1800	575	145T	WWE2-18-575-145T	\$401.47
3	1800	575	182T	WWE3-18-575-182T	\$523.41
5	1800	575	184T	WWE5-18-575-184T	\$565.43
7.5	1800	575	213T	WWE7.5-18-575-213T	\$778.41
10	1800	575	215T	WWE10-18-575-215T	\$898.68
15	1800	575	254T	WWE15-18-575-254T	\$1,333.16
20	1800	575	256T	WWE20-18-575-256T	\$1,514.31
25	1800	575	284T	WWE25-18-575-284T	\$2,103.53
30	1800	575	286T	WWE30-18-575-286T	\$2,290.44
40	1800	575	324T	WWE40-18-575-324T	\$2,987.39
50	1800	575	326T	WWE50-18-575-326T	\$3,819.63
60	1800	575	364T	WWE60-18-575-364T	\$5,045.54
75	1800	575	365T	WWE75-18-575-365T	\$5,834.29
100	1800	575	405T	WWE100-18-575-405T	\$6,657.00
125	1800	575	444T	WWE125-18-575-444T	\$9,671.43
150	1800	575	445T	WWE150-18-575-445T	\$10,490.07
200	1800	575	445/7T	WWE200-18-575-445/7T	\$14,114.94
250	1800	575	449T	WWE250-18-575-449T	\$17,860.09
300	1800	575	449T	WWE300-18-575-449T	\$25,194.90
300	1800	575	586/7	WWE300-18-575-586/7	\$30,943.58
350	1800	575	586/7	WWE350-18-575-586/7	\$33,689.02
400	1800	575	586/7	WWE400-18-575-586/7	\$34,713.25
450	1800	575	586/7	WWE450-18-575-586/7	\$40,082.56
500	1800	575	586/7	WWE500-18-575-586/7	\$41,588.89

* Prices In This Brochure Are List - Please Call For Your Multiplier

Industrial Duty Three-Phase Motors



Performance Data (1 HP - 50 HP)

Model Number	FL Amps 460 V	LRT (%)	BDT (%)	FL Eff. (%)	FL P.F.	S.F.
WWE1-18-143T	1.5	250	350	82.5	0.71	1.15
WWE1-18-575-143T	1.2	250	350	82.5	0.71	1.15
WWE1-12-145T	1.6	200	250	80.0	0.71	1.15
WWE1.5-36-143T	1.9	180	250	82.5	0.86	1.15
WWE1.5-18-145T	2.1	240	320	84.0	0.74	1.15
WWE1.5-18-575-145T	1.68	240	320	84.0	0.74	1.15
WWE1.5-12-182T	2.41	280	370	85.5	0.65	1.15
WWE2-36-145T	2.5	200	270	84.0	0.87	1.15
WWE2-18-145T	2.7	230	290	84.0	0.77	1.15
WWE2-18-575-145T	2.16	230	290	84.0	0.77	1.15
WWE2-12-184T	3.05	270	340	86.5	0.70	1.15
WWE3-36-145T	3.6	200	290	85.5	0.86	1.15
WWE3-36-182T	3.6	230	360	85.5	0.86	1.15
WWE3-18-182T	3.86	280	330	87.5	0.81	1.15
WWE3-18-575-182T	3.09	280	330	87.5	0.81	1.15
WWE3-12-213T	4.2	170	280	87.5	0.72	1.15
WWE5-36-184T	5.65	210	355	87.5	0.88	1.15
WWE5-18-184T	5.9	270	310	87.5	0.84	1.15
WWE5-18-575-184T	4.72	270	310	87.5	0.84	1.15
WWE5-12-215T	6.8	170	240	87.5	0.72	1.15
WWE5-9-254T	7.6	210	280	85.5	0.71	1.15
WWE7.5-36-184T	8.4	240	370	88.5	0.88	1.15
WWE7.5-36-213T	8.4	200	330	88.5	0.89	1.15
WWE7.5-18-213T	9.3	200	330	89.5	0.81	1.15
WWE7.5-18-575-213T	7.44	200	330	89.5	0.81	1.15
WWE7.5-12-254T	10.6	230	300	89.5	0.71	1.15
WWE7.5-9-256T	11.2	200	300	85.5	0.72	1.15
WWE10-36-215T	11.2	220	330	89.5	0.89	1.15
WWE10-18-215T	12.4	200	300	89.5	0.83	1.15
WWE10-18-575-215T	9.92	200	300	89.5	0.83	1.15
WWE10-12-256T	14.0	220	300	89.5	0.74	1.15
WWE10-9-284T	14.2	200	300	88.5	0.75	1.15
WWE15-36-215T	17.6	230	380	90.2	0.86	1.15
WWE15-36-254T	16.6	180	290	90.2	0.87	1.15
WWE15-18-254T	17.7	170	270	91.0	0.84	1.15
WWE15-18-575-254T	14.2	170	270	91.0	0.84	1.15
WWE15-12-284T	19.2	200	270	90.2	0.78	1.15
WWE15-9-286T	20.5	200	280	88.5	0.76	1.15

Model Number	FL Amps 460 V	LRT (%)	BDT (%)	FL Eff. (%)	FL P.F.	S.F.
WWE20-36-256T	22.5	170	260	90.2	0.88	1.15
WWE20-18-256T	23.8	170	260	91.0	0.84	1.15
WWE20-18-575-256T	19.0	170	260	91.0	0.84	1.15
WWE20-12-286T	25.9	180	240	90.2	0.80	1.15
WWE20-9-324T	27.3	160	230	89.5	0.77	1.15
WWE25-36-256T	28.0	150	240	91.0	0.89	1.15
WWE25-36-284T	27.9	180	260	91.0	0.87	1.15
WWE25-36-284TS	27.9	180	260	91.0	0.87	1.15
WWE25-18-284T	28.2	170	240	92.4	0.87	1.15
WWE25-18-575-284T	22.6	170	240	92.4	0.87	1.15
WWE25-18-284TS	28.2	170	240	92.4	0.87	1.15
WWE25-12-324T	30.0	180	270	91.7	0.77	1.15
WWE25-9-326T	33.3	160	230	89.5	0.78	1.15
WWE30-36-286T	32.9	200	290	91.0	0.89	1.15
WWE30-36-286TS	32.9	200	290	91.0	0.89	1.15
WWE30-18-286T	33.6	170	270	92.4	0.88	1.15
WWE30-18-575-286T	26.9	170	270	92.4	0.88	1.15
WWE30-18-286TS	33.6	170	270	92.4	0.88	1.15
WWE30-12-326T	35.4	170	260	91.7	0.78	1.15
WWE30-9-364T	38.9	170	230	91.0	0.78	1.15
WWE40-36-286T	45.0	160	280	91.7	0.88	1.15
WWE40-36-286TS	45.0	160	280	91.7	0.88	1.15
WWE40-36-324T	46.3	220	300	91.7	0.88	1.15
WWE40-36-324TS	46.3	220	300	91.7	0.88	1.15
WWE40-18-324T	46.5	190	290	93.0	0.86	1.15
WWE40-18-575-324T	37.4	190	290	93.0	0.86	1.15
WWE40-18-324TS	46.5	190	290	93.0	0.86	1.15
WWE40-12-364T	47.5	170	250	93.0	0.82	1.15
WWE40-9-365T	52.4	170	200	91.0	0.79	1.15
WWE50-36-326T	56.7	210	300	92.4	0.88	1.15
WWE50-36-326TS	56.7	210	300	92.4	0.88	1.15
WWE50-18-326T	57.3	180	280	93.0	0.86	1.15
WWE50-18-575-326T	45.8	180	280	93.0	0.86	1.15
WWE50-18-326TS	57.3	180	280	93.0	0.86	1.15
WWE50-12-365T	58.3	170	250	93.0	0.81	1.15
WWE50-9-404T	65.0	168	215	91.7	0.78	1.15

Industrial Duty Three-Phase Motors



Performance Data (60 HP - 500 HP)

Model Number	FL Amps 460 V	LRT (%)	BDT (%)	FL Eff. (%)	FL P.F.	S.F.
WWE60-36-364T	66.9	210	260	93.0	0.87	1.15
WWE60-36-364TS	66.9	210	260	93.0	0.87	1.15
WWE60-18-364T	69.7	180	270	93.6	0.85	1.15
WWE60-18-575-364T	55.8	180	270	93.6	0.85	1.15
WWE60-18-364TS	69.7	180	270	93.6	0.85	1.15
WWE60-12-404T	71.0	180	250	93.6	0.83	1.15
WWE60-9-405T	80.0	180	230	91.7	0.77	1.15
WWE75-36-365T	83.2	200	250	93.0	0.87	1.15
WWE75-36-365TS	83.2	200	250	93.0	0.87	1.15
WWE75-18-365T	86.4	180	240	94.1	0.84	1.15
WWE75-18-575-365T	69.1	180	240	94.1	0.84	1.15
WWE75-18-365TS	86.4	180	240	94.1	0.84	1.15
WWE75-12-405T	89.0	180	240	93.6	0.84	1.15
WWE75-9-444T	95.0	145	215	93.0	0.78	1.15
WWE100-36-405TS	110	160	260	93.6	0.89	1.15
WWE100-18-405T	115	200	290	94.5	0.87	1.15
WWE100-18-575-405T	92.0	200	290	94.5	0.87	1.15
WWE100-18-405TBB	115	200	290	94.5	0.87	1.15
WWE100-18-405TSBB	115	200	290	94.5	0.87	1.15
WWE100-12-444T	119	160	260	94.1	0.82	1.15
WWE100-9-445T	131	135	210	93.0	0.77	1.15
WWE125-36-444TS	137	120	240	94.5	0.90	1.15
WWE125-18-444T	137	170	250	94.5	0.86	1.15
WWE125-18-575-444T	110	170	250	94.5	0.86	1.15
WWE125-18-444TBB	137	170	250	94.5	0.86	1.15
WWE125-18-444TSBB	137	170	250	94.5	0.86	1.15
WWE125-12-445T	141	150	240	94.1	0.81	1.15
WWE125-9-445/T	154	145	210	93.6	0.78	1.15
WWE150-36-445TS	166	170	290	94.5	0.88	1.15
WWE150-18-445T	163	180	250	95.0	0.87	1.15
WWE150-18-575-445T	130	180	250	95.0	0.87	1.15
WWE150-18-445TBB	163	180	250	95.0	0.87	1.15
WWE150-18-445TSBB	163	180	250	95.0	0.87	1.15
WWE150-12-445/T	171	160	250	95.0	0.83	1.15
WWE150-9-449T	186	210	290	94.5	0.79	1.15
WWE200-36-447TS	219	170	270	95.0	0.91	1.15
WWE200-18-445/T	223	200	280	95.0	0.87	1.15
WWE200-18-575-445/T	178	200	280	95.0	0.87	1.15
WWE200-18-445/TBB	223	200	280	95.0	0.87	1.15
WWE200-18-445/TTSBB	223	200	280	95.0	0.87	1.15
WWE200-12-449T	245	200	292	95.0	0.82	1.15
WWE200-12-505Z(UZ)	230	180	280	95.0	0.87	1.15
WWE200-9-449T	250	200	270	94.3	0.81	1.15

Model Number	FL Amps 460 V	LRT (%)	BDT (%)	FL Eff. (%)	FL P.F.	S.F.
WWE250-36-449TS	267	180	290	95.0	0.88	1.15
WWE250-18-449T	282	228	330	95.9	0.87	1.15
WWE250-18-575-449T	226	228	330	95.9	0.87	1.15
WWE250-18-449TBB	282	228	330	95.9	0.87	1.15
WWE250-18-449TSBB	282	228	330	95.9	0.87	1.15
WWE250-18-505Z(UZ)	276	190	270	94.8	0.90	1.15
WWE250-12-449T	300	188	279	95.4	0.82	1.15
WWE250-12-586/7(UZ)	286	180	280	94.5	0.86	1.15
WWE250-9-586/7(UZ)	309	180	290	94.4	0.79	1.15
WWE300-18-449T	334	226	326	95.7	0.88	1.15
WWE300-18-575-449T	267	226	326	95.7	0.88	1.15
WWE300-18-449TBB	334	226	326	95.7	0.88	1.15
WWE300-18-449TSBB	334	226	326	95.7	0.88	1.15
WWE300-18-586/7(UZ)	328	190	280	95.0	0.89	1.15
WWE300-18-575-586/7	262	190	280	95.0	0.89	1.15
WWE300-18-586/7BB	328	190	280	95.0	0.89	1.15
WWE300-12-449T	355	191	280	94.5	0.82	1.15
WWE300-12-586/7(UZ)	328	180	290	95.4	0.88	1.15
WWE300-9-586/7	364	180	290	94.9	0.80	1.15
WWE350-18-586/7(UZ)	385	180	270	95.0	0.89	1.15
WWE350-18-575-586/7	308	180	270	95.0	0.89	1.15
WWE350-18-586/7UZBB	385	180	270	95.0	0.89	1.15
WWE350-12-586/7(UZ)	393	180	280	95.1	0.87	1.15
WWE400-18-586/7(UZ)	430	200	300	95.3	0.90	1.15
WWE400-18-575-586/7	344	200	300	95.3	0.90	1.15
WWE400-18-586/7BB	430	200	300	95.3	0.90	1.15
WWE400-12-586/7(UZ)	444	170	300	95.0	0.88	1.15
WWE450-18-586/7(UZ)	478	200	320	96.1	0.90	1.0
WWE450-18-575-586/7	382	200	320	96.1	0.90	1.0
WWE450-12-586/7(UZ)	501	190	307	95.8	0.86	1.0
WWE500-18-586/7(UZ)	539	228	320	95.8	0.90	1.15
WWE500-18-575-586/7	431	228	320	95.8	0.90	1.15
WWE500-18-586/7BB	539	228	320	95.8	0.90	1.15
WWE500-12-586/7(UZ)	557	225	270	95.0	0.87	1.0

**All Ratings Meet Or
Exceed EPACT Levels**

Industrial Duty Three-Phase Motors

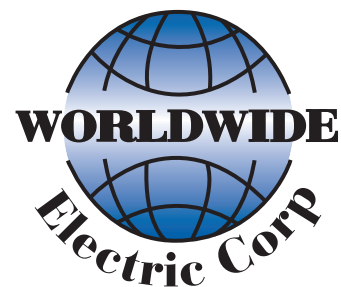

Dimensions (Frames 143T - 586/7UZ)

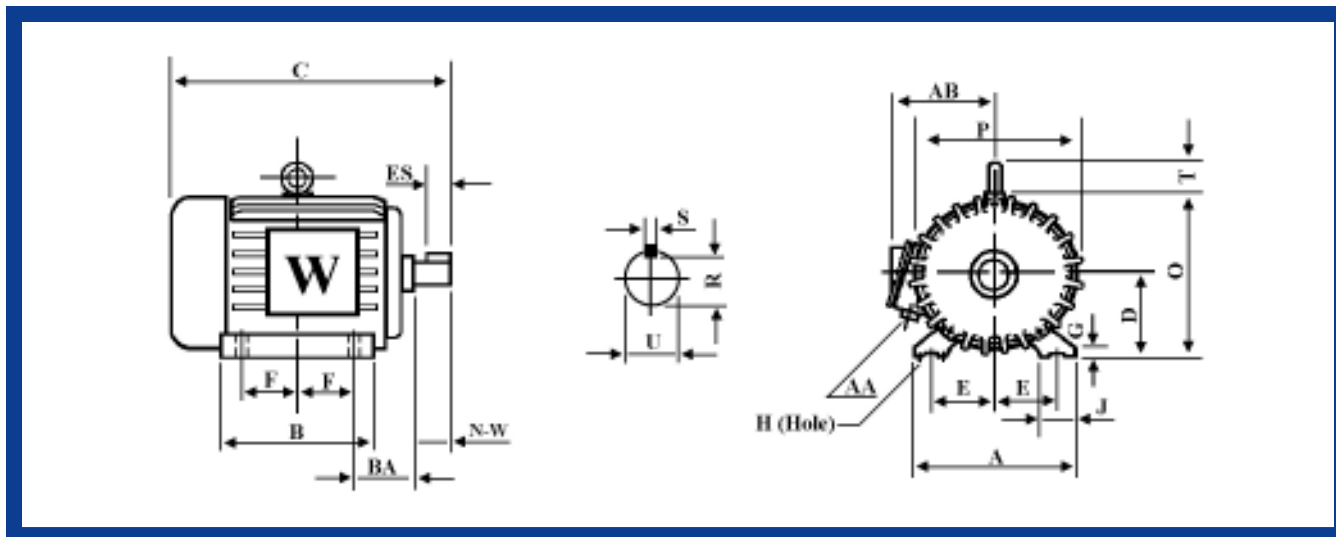

Frame Size	A	B	C	D	E	F	G	H	J	N-W	O	P	R	S	T	U	ES	AA	AB	BA
143T	7	5	12.47	3.5	2.75	2	0.512	0.34	1.45	2.25	7.08	7.16	0.771	0.188	---	0.875	1.41	3/4	6.89	2.25
145T	7	6	13.466	3.5	2.75	2.5	0.512	0.34	1.45	2.25	7.08	7.16	0.771	0.188	---	0.875	1.41	3/4	6.89	2.25
182T	9	6.5	15.11	4.5	3.75	2.25	0.59	0.41	1.97	2.75	9	8.82	0.986	0.25	1.4	1.125	1.78	1	7.45	2.75
184T	9	7.5	16.116	4.5	3.75	2.75	0.59	0.41	1.97	2.75	9	8.82	0.986	0.25	1.4	1.125	1.78	1	7.45	2.75
213T	10.5	7.5	18.89	5.25	4.25	2.75	0.709	0.41	2.36	3.375	10.5	10.4	1.201	0.312	1.75	1.375	2.41	1	8.63	3.5
215T	10.5	9	20.488	5.25	4.25	3.5	0.709	0.41	2.36	3.375	10.5	10.4	1.201	0.312	1.75	1.375	2.41	1	8.63	3.5
254T	12.5	10.8	23.292	6.25	5	4.125	0.787	0.53	2.76	4	12.79	12.6	1.416	0.375	2.15	1.625	2.91	1.5	11.2	4.25
256T	12.5	12.5	25.058	6.25	5	5	0.787	0.53	2.76	4	12.79	12.6	1.416	0.375	2.15	1.625	2.91	1.5	11.2	4.25
284T	14	12.5	26.63	7	5.5	4.75	0.866	0.53	2.76	4.625	13.98	13.98	1.591	0.5	2.35	1.875	3.28	1.5	12	4.75
284TS	14	12.5	25.25	7	5.5	4.75	0.866	0.53	2.76	3.25	13.98	13.98	1.416	0.375	2.35	1.625	1.91	1.5	12	4.75
286T	14	14	28.182	7	5.5	5.5	0.866	0.53	2.76	4.625	13.98	13.98	1.591	0.5	2.35	1.875	3.28	1.5	12	4.75
286TS	14	14	26.8	7	5.5	5.5	0.866	0.53	2.76	3.25	13.98	13.98	1.416	0.375	2.35	1.625	1.91	1.5	12	4.75
324T	16	14	29.95	8	6.25	5.25	0.984	0.66	2.76	5.25	15.8	15.55	1.845	0.5	2.55	2.125	3.91	2	13.4	5.25
324TS	16	14	28.45	8	6.25	5.25	0.984	0.66	2.76	3.75	15.8	15.55	1.591	0.5	2.55	1.875	2.03	2	13.4	5.25
326T	16	15.5	31.236	8	6.25	6	0.984	0.66	2.76	5.25	15.8	15.55	1.845	0.5	2.55	2.125	3.91	2	13.4	5.25
326TS	16	15.5	29.74	8	6.25	6	0.984	0.66	2.76	3.75	15.8	15.55	1.591	0.5	2.55	1.875	2.03	2	13.4	5.25
364T	18	15.2	32.58	9	7	5.625	1.102	0.66	2.95	5.875	18.02	17.4	2.021	0.625	2.55	2.375	4.28	3	15.7	5.88
364TS	18	15.2	30.45	9	7	5.625	1.102	0.66	2.95	3.75	18.02	17.4	1.591	0.5	2.55	1.875	2.03	3	15.7	5.88
365T	18	16.2	34.114	9	7	6.125	1.102	0.66	2.95	5.875	18.02	17.4	2.021	0.625	2.55	2.375	4.28	3	15.7	5.88
365TS	18	16.2	31.45	9	7	6.125	1.102	0.66	2.95	3.75	18.02	17.4	1.591	0.5	2.55	1.875	2.03	3	15.7	5.88
404T	20	16.2	36.81	10	8	6.125	1.18	0.81	3.15	7.25	20.91	21.42	2.45	0.75	2.55	2.875	5.65	3	18.07	6.62
405T	20	17.8	38.35	10	8	6.875	1.18	0.81	3.15	7.25	20.91	21.42	2.45	0.75	2.55	2.875	5.65	3	18.07	6.62
405TS	20	17.8	35.354	10	8	6.875	1.18	0.81	3.15	4.25	20.91	21.42	1.845	0.5	2.55	2.125	2.78	3	18.07	6.62
444T	22	18.5	42.52	11	9	7.25	1.38	0.81	3.35	8.5	23.68	23.43	2.88	0.875	2.75	3.375	6.91	2 x 3	19.07	7.5
444TS	22	18.5	38.94	11	9	7.25	1.38	0.81	3.35	4.75	23.68	23.43	2.021	0.625	2.75	2.375	3.03	2 x 3	19.07	7.5
445T	22	20.5	44.5	11	9	8.25	1.38	0.81	3.35	8.5	23.68	23.43	2.88	0.875	2.75	3.375	6.91	2 x 3	19.07	7.5
445TS	22	20.5	40.71	11	9	8.25	1.38	0.81	3.35	4.75	23.68	23.43	2.021	0.625	2.75	2.375	3.03	2 x 3	19.07	7.5
447T	22	24	48.03	11	9	10	1.38	0.81	3.35	8.5	23.68	23.43	2.88	0.875	2.75	3.375	6.91	2 x 3	19.07	7.5
447TS	22	24	44.25	11	9	10	1.38	0.81	3.35	4.75	23.68	23.43	2.021	0.625	2.75	2.375	3.03	2 x 3	19.07	7.5
449T	22	31	55.27	11	9	12.5	1.575	0.81	3.35	8.5	23	23.62	2.88	0.875	4.25	3.375	6.91	2 x 3	19	7.5
505UZ	24.7	26	55	12.5	10	9	1.77	0.938	4.72	11.625	25.2	24.8	3.309	1	4.3	3.875	10	2 x 3	20.9	8.5
586/7	28.7	31.1	64.6	14.5	11.5	11	2.05	1.125	4.72	11.625	28.4	28.2	3.309	1	5	3.875	10	2 x 3	23.9	10
586/7UZ	28.7	31.1	64.6	14.5	11.5	11	2.05	1.125	4.72	11.625	28.4	28.2	3.817	1	5	4.375	10	2 x 3	23.9	10